

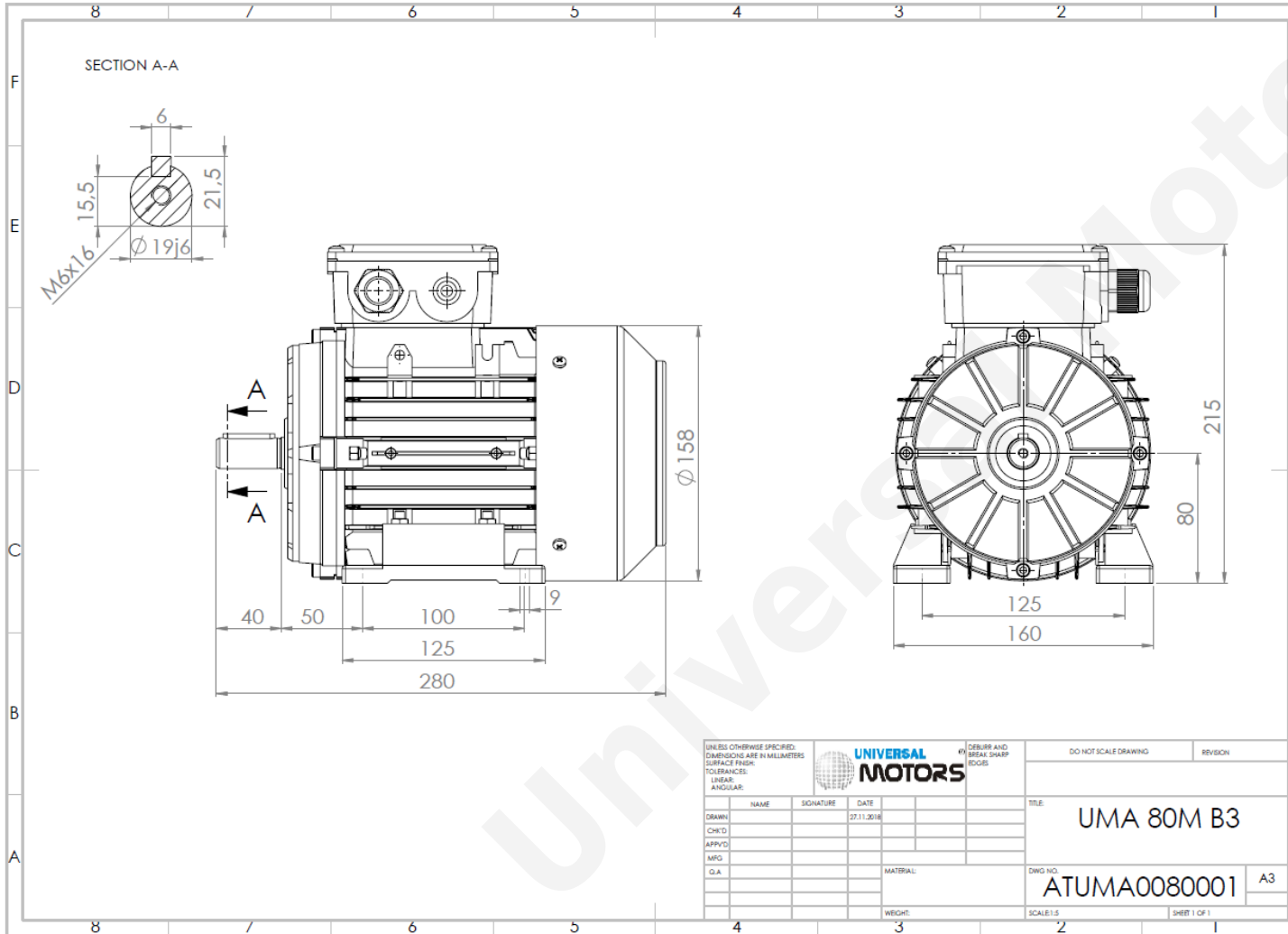

# TECHNICAL DATA

Three Phase Electric Motors - Aluminum Frame  
 UM2A 80M2-2  
 1.1 kW / 1.5 Cv  
 2860 RPM



Motor type:	<b>UM2A 80M2-2</b>
Output:	<b>1.1 kW / 1.5 Cv</b>
Speed (min <sup>-1</sup> ):	<b>2860 RPM</b>
Frequency:	<b>50 Hz</b>
Voltage:	<b>400 V</b>
Current:	<b>2.43 A</b>
Power factor (Cos $\phi$ ):	<b>0.82</b>
Poles:	<b>2</b>
Insulation class:	<b>F</b>
Temperature rise Class:	<b>B</b>
Efficiency 50%:	<b>77.5 %</b>
Efficiency 75%:	<b>79.9 %</b>
Efficiency 100%:	<b>79.6 %</b>
Torque:	<b>3.7 N.m</b>
Tstarting/Tnominal:	<b>2.6</b>
Istarting/Inominal:	<b>7.0</b>
Tmaximum/Tnominal:	<b>2.6</b>
Noise:	<b>67 Db(A)</b>
Weight:	<b>9.8 Kg</b>
Brake AC:	<b>AC3</b>
Torque Brake DC:	<b>8 N.m</b>
Bearing DE:	<b>6204 2Z</b>
Bearing NDE:	<b>6204 2Z</b>
Torque Brake AC:	<b>15 N.m</b>
Brake DC:	<b>REB-05-08</b>

Regime - S1

Altitude - 1000m

Environment Temperature - 40°C

## CONTACTS:

UNIVERSAL MOTORS Tel: +351 252 299 080  
 Rua de São Brás,745 Fax: +351 252 299 089  
 4480-782 VILA DO CONDE Mail: [geral@universalmotors.pt](mailto:geral@universalmotors.pt)

\* References applied only in the UK